

Total solder points: 61
Difficulty level: *beginner* 1 2 3 4 5 *advanced*

TELEPHONE RING DETECTOR WITH RELAY OUTPUT

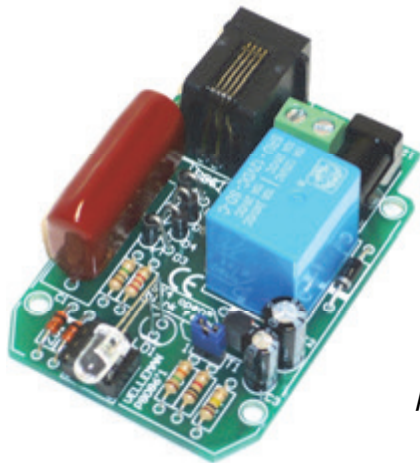

K8086

Simply connect in parallel with phone line.
Accepts standard adaptor & telephone plug.

Features:

- simply connect in parallel with phone line
- powerful led flashes when phone rings
- the unit will feature a relay output if connected to a 12VDC power supply
- relay output: continuous or on/off to the rhythm of ringing of the telephone
- complete with enclosure
- great for noisy environments, for the hearing impaired, as additional ringer, to replace existing ringer, ...
- accepts standard adaptor & telephone plug

Specifications:

- 10.000 mcd led !
- connects to PSTN line
- RJ11 connector
- supply: 12VDC/100mA adapter (Ex. [PS1203](#))
- output Contact (NO): 1A max.
- dimensions: 80x55x35mm / 3,15 x 2,16 x 1,37"

Includes:

- attractive enclosure
- adhesive strips for easy fixing

1. Assembly (Skipping this can lead to troubles !)

Ok, so we have your attention. These hints will help you to make this project successful. Read them carefully.

1.1 Make sure you have the right tools:

- A good quality soldering iron (25-40W) with a small tip.
- Wipe it often on a wet sponge or cloth, to keep it clean; then apply solder to the tip, to give it a wet look. This is called 'thinning' and will protect the tip, and enables you to make good connections. When solder rolls off the tip, it needs cleaning.
- Thin rosin-core solder. Do not use any flux or grease.
- A diagonal cutter to trim excess wires. To avoid injury when cutting excess leads, hold the lead so they cannot fly towards the eyes.
- Needle nose pliers, for bending leads, or to hold components in place.
- Small blade and Phillips screwdrivers. A basic range is fine.

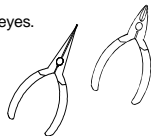

For some projects, a basic multi-meter is required, or might be handy

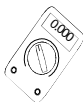

1.2 Assembly Hints :

- ⇒ Make sure the skill level matches your experience, to avoid disappointments.
- ⇒ Follow the instructions carefully. Read and understand the entire step before you perform each operation.
- ⇒ Perform the assembly in the correct order as stated in this manual
- ⇒ Position all parts on the PCB (Printed Circuit Board) as shown on the drawings.
- ⇒ Values on the circuit diagram are subject to changes, the values in this assembly guide are correct*
- ⇒ Use the check-boxes to mark your progress.
- ⇒ Please read the included information on safety and customer service

* Typographical inaccuracies excluded. Always look for possible last minute manual updates, indicated as 'NOTE' on a separate leaflet.

1.3 Soldering Hints :

1- Mount the component against the PCB surface and carefully solder the leads



2- Make sure the solder joints are cone-shaped and shiny



3- Trim excess leads as close as possible to the solder joint



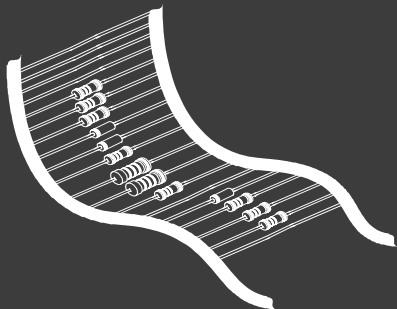

REMOVE THEM FROM THE TAPE ONE AT A TIME !

Included in
this kit



2. RESISTOR

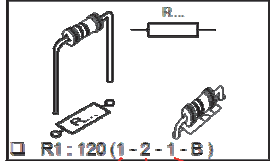

COLOUR	COLOUR NAME	1ST DIGIT/ STRIPE	END DIGIT/ STRIPE	3RD DIGIT/ STRIPE	MULTIPLIER STRIPE	TOLERANCE
Black	BLACK	0	0	0	x1	1%
Brown	BROWN	1	1	1	x10	
Red	RED	2	2	2	x100	
Orange	ORANGE	3	3	3	x1.000	
Yellow	YELLOW	4	4	4	x10.000	
Green	GREEN	5	5	5	x100.000	
Blue	BLUE	6	6	6	x1.000.000	

**DO NOT BLINDLY FOLLOW THE ORDER OF THE COMPONENTS ONTO THE TAPE.
ALWAYS CHECK THEIR VALUE ON THE PARTS LIST!**

1. Diodes. Watch the polarity!

- D1 : 1N4148
- D2 : 1N4007

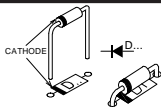

4. IC socket, Watch the position of the notch!

- IC1 : 6P

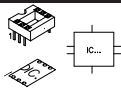

7. Transistor

- T1 : BC557B

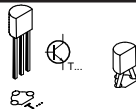

2. Zener diodes. Watch the polarity!

- ZD1 : 20V0
- ZD2 : 20V0

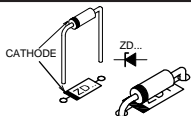

5. Vertical diodes. Watch the polarity!

- D3 : 1N4007
- D4 : 1N4007
- D5 : 1N4007
- D6 : 1N4007



8. Electrolytic Capacitors. Watch the polarity!

- C2 : 100µF / 25V
- C3 : 47µF / 25V

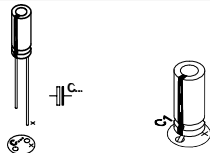

3. Resistors

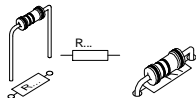

- R1 : 1M (1 - 0 - 5 - B)
- R2 : 2K2 (2 - 2 - 2 - B)
- R3 : 15K (1 - 5 - 3 - B)
- R4 : 100K (1 - 0 - 4 - B)
- R5 : 1K (1 - 0 - 2 - B)

6. Pinheader + shunt

- SK4 : 2p

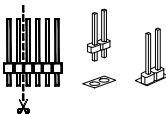

open = blink relay
closed = continuous relay

9. Terminal blocks

- SK3 : 2p

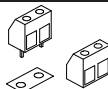

10. DC-jack

□ SK2 : 12VDC

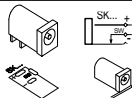
**11. LED. Watch the polarity!**

□ LD1 : 5mm (super red)

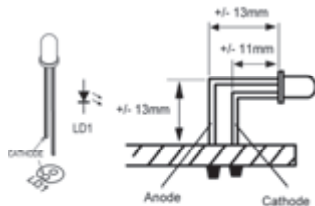
**12. Modular Jack**

□ SK1 : 4p (type RJ11)

**15. IC, watch the position of the notch!**

□ IC1 : 4N27

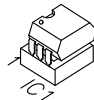
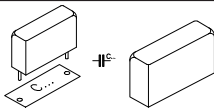
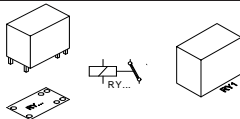
**13. Capacitor**□ C1 : 1 μ F / 275VAC**14. Relay**

□ RY1 : VR15M121C

16. Connection examples

1. LED flash

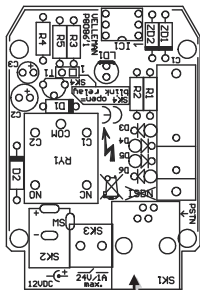

2. LED flash + relay output

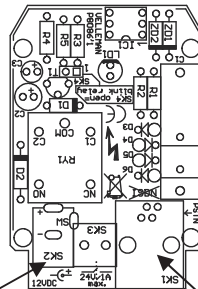

output mode selection



blinking relay output



continuous relay output

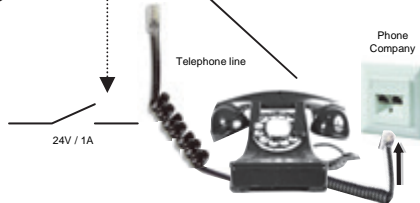

17. Assembly

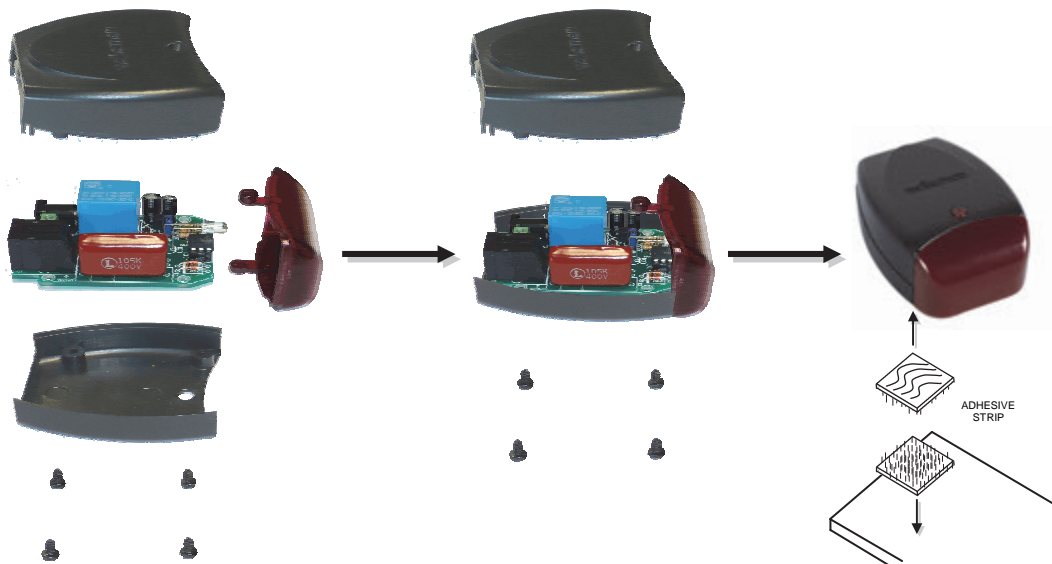

Schematic diagram.

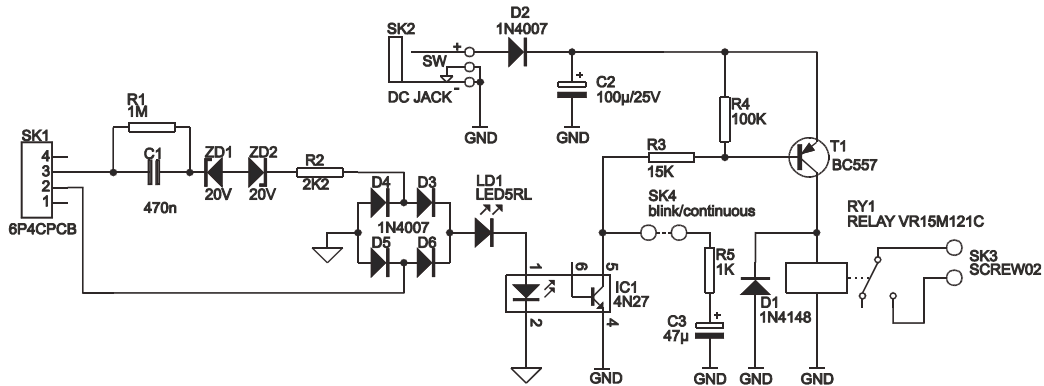

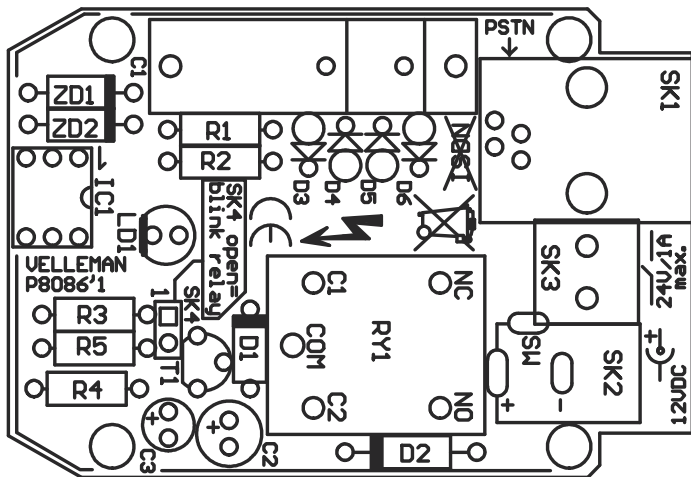



VELLEMAN NV

Legen Heirweg 33

9890 Gavere

Belgium Europe

www.velleman.be

www.velleman-kit.com

EDU 01**SOLDERLESS EDUCATIVE STARTERBOX**

The EDU01 basic experiment kit is the first step into the world of modern electronics. Build your own circuits in a fun, safe and educative way.

AVAILABLE**EDU 02****SOLAR ENERGY EXPERIMENT KIT**

Fun solar powered projects. Learn all about solar energy.

AVAILABLE**EDU 03****SOLDER EDUCATIVE STARTER BOX**

Learn how to solder, build different exciting projects. Includes spare components and demo boards.

COMING SOON**EDU 04****PIC™ TUTOR KIT**

Enter the world of microcontroller programming, easy step by step instructions. Includes programmer and test board.

COMING SOON**EDU 05****USB TUTOR BOARD**

Learn how to connect your computer with the outside world, master the USB communication with tutorial examples. Play with LED indicators and learn how to drive LCD displays.

COMING SOON**EDU 06****SCOPE EDUKIT**

This board with different signals will teach you how to use an oscilloscope. Optimized instructions for use of our HPS140 oscilloscope. YouTube demo movies.

COMING SOON